



An Investigation to the Atmospheric Effects on Generating Harmonic Distortion in a Solar Farm

Seyed Mohsen Salehi^a, Saeed Hasanzadeh^{b,*}, Seyed Mohammad Dehghan^c

^{a,c} Department of Electrical and Computer Engineering, Qom university of Technology, Qom, Iran

^{b,*} Department of Electrical and Computer Engineering, Qom university of Technology, Qom, Iran, Email: Hasanzadeh@qut.ac.ir

ARTICLE INFO

Received:
Received in revised form:
Accepted:
Available online:

Keywords:

Solar Systems;
Sun Tracker System;
Power System Harmonics;
Harmonic Distortion;
Power Quality

A B S T R A C T

Due to the increasing penetration rate of solar systems in electrical power distribution networks, the technical studies are required on power quality standards of utility grid Caused by solar system effects. This paper investigates the solar system connected to the utility grid in the view of the harmonic effects. The effects of temperature and sunlight changes are discussed on the harmonics produced by solar cells and its effect on the distribution network and the performance of its various components. Furthermore, Analysis of the current THD is carried out for the two cases, using and without using sun tracker technology at the point of common coupling between the solar system and utility grid. Then, the results are compared with each other. The obtained harmonic distortion values are compared with the specified limits in the standard IEEE STD 519-1992. Finally, simulation results verify the environmental model of a photovoltaic system.

© 2019 Published by University of Tehran Press. All rights reserved.

1. Introduction

Recently, Solar photovoltaic (PV) systems are quickly growing in distribution networks. Solar Energy considers as one of the most auspicious solutions to fulfill the electricity demand in the present and future. PV systems include power electronic devices that have an influence on the power quality of the grid in the form of harmonic distortion [1-2]. Power electronics in residential and commercial loads are a key source of distribution system harmonics, and the proportion of power electronics-based loads is projected for sustained growth in the future [3-4].

The presence of harmonics is one of the most important issues of power quality in utility networks. Harmonics are produced due to the nonlinear behavior of loads [5]. Moreover, solar systems connected to the utility network can impose a negative impact on the power quality indexes. These impacts on utility network characteristics will be more and more affected by both, the harmonics injected from the non-linear loads and solar systems. Some research focused on investigating the above-mentioned effects on the utility grid [6-7]. To tackle this challenge, a new strategy is presented for harmonic

reduction using grid-connected photovoltaic inverters by using the Discrete Fourier Transform method and considering the free capacity of the inverter [8]. Furthermore, an optimal passive harmonic filter planning is proposed for THD mitigation from a cost objective function perspective [9].

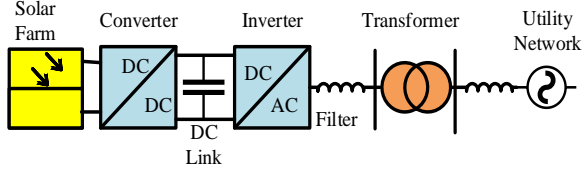

Figure 1. a solar system connected to the network

This paper presents an investigation of the atmospheric effects on generating harmonic distortion in a solar farm. The model used in this study is based on [10] as shown in Fig. 1. In the following, different parts of a solar interconnected network are discussed. Since the study requires software for simulation of the solar system, PSCAD has been chosen to simulate the interconnected solar system network [11]. In section II, the details of an interconnected solar system network are described including model, control, and performance of various components. In section III, harmonic distortion analysis injected from the solar systems connected to the network is studied with changing weather conditions during the day with and without using the sun tracker. All the results will be discussed based on the standard IEEE519-1992 [12].

2. Solar System Model

As shown in Fig. 2, solar system model used in this study includes a solar farm, DC link capacitor, DC-DC converter, and the maximum power point tracker system, three-phase inverter, AC filter, transformer, and the utility grid. In the following, different parts of a solar interconnected network are discussed.

Solar Cell

A solar cell is formed from semiconductor devices that produce electricity by the photovoltaic effect. The equivalent circuit of the solar cell used in modelling and the value of its parameters are shown in Fig. 3. (1) and (2) definite solar cell relations [6].

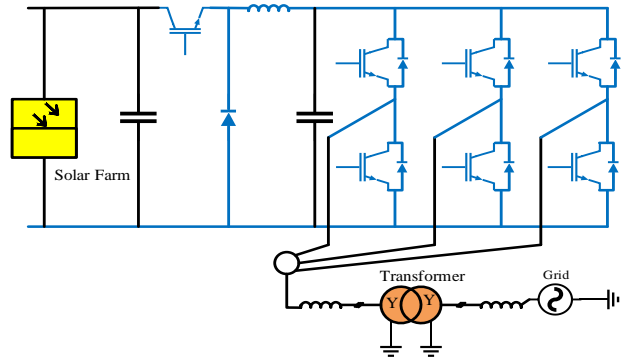

Figure 2. schematic of the solar system

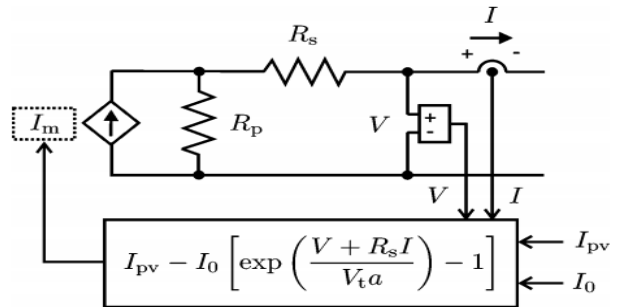

Figure 3. The equivalent circuit of a solar cell.

$$I_o = I_{on} \left[\frac{T_n}{T} \right]^3 \exp \left[\frac{qE_g}{ak} \left(\frac{1}{T_n} - \left(\frac{1}{T} \right) \right) \right] \quad (1)$$

$$I_{pv} = (I_{pv, n} + K_I \Delta T) \frac{G}{G_n} \quad (2)$$

where T is the temperature between P and N junction of solar cells in terms of K , K is Boltzmann's constant, a is the constant of ideal diode, R_s is the equivalent resistance of series solar arrays, G is the amount of solar radiation on the cell surface in terms of watt per square meters and G_n is the nominated solar radiation on the surface of the solar cell.

The model can use a certain number of cells in series and parallel connection to form a solar farm with the ability to provide high electrical power. the power output of each cell is 650 watts. so, for the total number of 400 solar cells is equal to 260 kW. Increasing the amount of solar radiation can increase the short circuit current while increasing the temperature can reduce the open-circuit voltage of the solar cell.

DC-DC Converter

DC-DC converter plays an important role in solar systems[13-14]. Here, the DC-DC converter is a buck

converter that is used to maximum power point tracker by controlling the voltage across the DC link capacitor and solar cell arrays. By producing the reference voltage that feeds a PI controller and the switching signals of the DC-DC converter, the voltage across the solar cell follows the reference value.

Maximum Power Point Tracker (MPPT)

In Fig. 4, a maximum power point tracking model to generate the reference voltage is shown. At the first, solar cell output current (I_{PV}) and its output voltage (V_{PV}) are passed from a first-order low-pass filter. To filter out high-frequency components, the time constant is $T = 0.01$ seconds and the gain is $G = 1$. The filtered voltage and current signals (I_{PVF}, V_{PVF}) feeds the maximum power point tracker which uses algorithms of increasing conductivity. This algorithm is based on the slope of the output power curve of the solar cell. The output power of a solar cell (axis y) versus its voltage (axis x). The curve is shown in Fig. 5. As it is seen at the maximum power point, the slope of this curve is zero with positive and negative slope at the left and right-hand side of the point. Therefore, the maximum power point is tracked by comparing I/V and $\Delta I/\Delta V$ based on (3) [15].

$$\begin{cases} \Delta I/\Delta V = -I/V & \text{maximum point} \\ \Delta I/\Delta V > -I/V & \text{left side} \\ \Delta I/\Delta V < -I/V & \text{right side} \end{cases} \quad (3)$$

The maximum power point tracker produces the voltage reference (V_{MPPT}). The algorithm V_{MPPT} is increased or decreased to tracking the maximum power point according to climate variations. The reference voltage is used as a control input of the DC-DC converter.

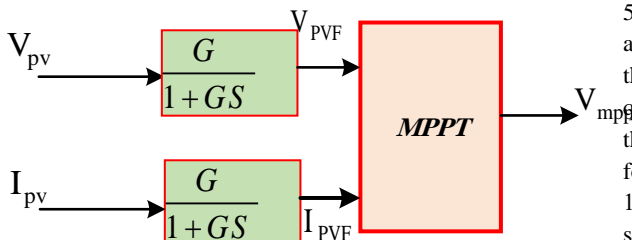

Figure 4. The model of maximum power point tracker

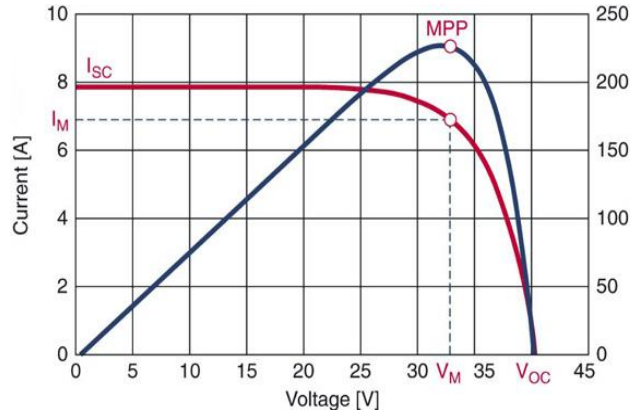

Figure 5. The output power of a solar cell versus its voltage.

Three-Phases Inverter

To join a solar system to a utility grid, the DC output power of the buck converter should be converted to a three-phase AC voltage using a three-phase inverter. Also, the inverter should maintain the input DC voltage (the output of the DC-DC converter) at a constant amount. In the simulated model, the three-phase inverter includes a simple active and reactive power regulator circuit, the fire pulse generator and a three-phase bridge inverter.

Utility Grid

The model of the utility grid system concerning the standard range of medium voltage in Iran is equivalent to a source of 20 kV and 50 Hz. As illustrated in Fig. 2, there is a system inductive impedance located behind the source.

Tracking Solar Array

If the surface of solar cells that receives the energy of the sun, moves with the motion of the sun, get the energy of the solar cells will increase. In the days when the arc motion of the sun and its radiation are high, the solar tracker system resulted in a significant increase in power. Using the tracking system in summer and in winter about 50 percent and 20 percent respectively more energy will be absorbed. Moreover, using the solar array tracker increases the number of hours of getting solar energy to meet power quality standards. Variations of the sunlight radiation on the surface of the solar cell, during different hours of a day for the longest and shortest days of a year, 20th June with 16 hours' sunlight and 20th December with 10-hour sunlight respectively, are illustrated in Fig. 6. Two cases of using sun tracker and without using it, are shown comparably. As it is seen, the sun tracker has a significant effect on the value of absorbed energy [11,16].

3. Analysis of Harmonic Distortion

Harmonics are sinusoidal components of a signal with frequencies multiple of the fundamental frequency. Harmonics in solar systems are due to the switching of converters that do not generate a complete sinusoidal wave. Both solar systems connected to the network and non-linear loads that are already connected to the grid inject harmonic. Therefore, more stress is forced into the grid power quality index. To maintain power quality at an acceptable level, some standards for distributed systems must be set and applied. The IEEE STD 929-2000 is one of the main that gives practical recommendations contains guidance regarding equipment and functions necessary to ensure compatible operation of photovoltaic (PV) systems that are connected in parallel with the electric utility [17]. Also, harmonic distortion recommendations that are presented in the standard IEEE STD 519-1992 must be met at the point of common coupling where the solar system is connected to the medium-voltage network.

In the model, the point of common coupling (PCC) is placed between the transformer and the electric network. It should ensure that the output current of the solar system has an acceptable level of harmonics. It requires attention to section 10 of the standard IEEE STD 519-1992 that is summary is presented in the following. Total harmonic distortion of current should be less than 5% of the main component of inverter output current. Each harmonic component should have a percentage with limits listed in Table 1. The limits of Table 1 are related to the point of common coupling. It should be noted that even harmonics are less than 25% of odd ones in their ranges.

4. Simulation Results

Fig. 7 depicts the total harmonic distortion of phase A current at the point of common coupling as a percentage of the main harmonic. In this case, sunlight has been modeled based on Fig. 6 on 20th June using sun tracker technology. As is seen in Fig. 6, 16 hours is available to extract solar energy, but according to what is specified in Fig. 7,

considering a total harmonic distortion of phase A, 10 hours (7 to 17) meets the standard IEEE STD 519-1992 limits. Fig. 8 illustrates individual harmonic distortion at 7 o'clock. It is clear that the total harmonic distortion of the current of the point of common coupling is less than 5% in 10 hours during the day, as well as the limitations of Table 1, are met. As depicted in Fig. 9, without using sun tracker technology, only in five hours (9 to 14) total harmonic distortion is less than the limits of the standard. Fig. 10 illustrates individual harmonic distortion at 9 o'clock.

As illustrated in Fig. 6, only in 10 hours (7 to 17) of the day there is the sunlight on 20th December. According to Fig. 11 and the percentage of total harmonic distortion of phase current at the PCC and using the technology of the sun tracker, only in 2 hours (11 to 13) meets the standard IEEE STD 519-1992 limits are met and at other times of the day, it exceeds the standard limits. Fig. 12 shows different harmonic distortion at 11 o'clock which are less than the limits of Table 1. Fig. 13 illustrates the total harmonic distortion of the current of phase A at the point of common coupling without using a sun tracker technology on 20th December. As it is seen the total harmonic distortion of phase A exceeds the limits of standard IEEE STD 519-1992 during the day. So the sunlight energy is not effectively absorbed. Therefore, the need for a sun tracker technology is essential. In Fig. 14, individual harmonic distortion at 12 o'clock is illustrated which is more than the limits of Table 1.

Table 1. Harmonic distortion limits of current at common coupling point for a six pulses converter based on the standard IEEE STD 519-1992.

Odd harmonics	Distortion limits
9-11	>4%
11-15	>2%
17-21	>1.5%
21-23	>0.6%
Higher than 23	>0.3%

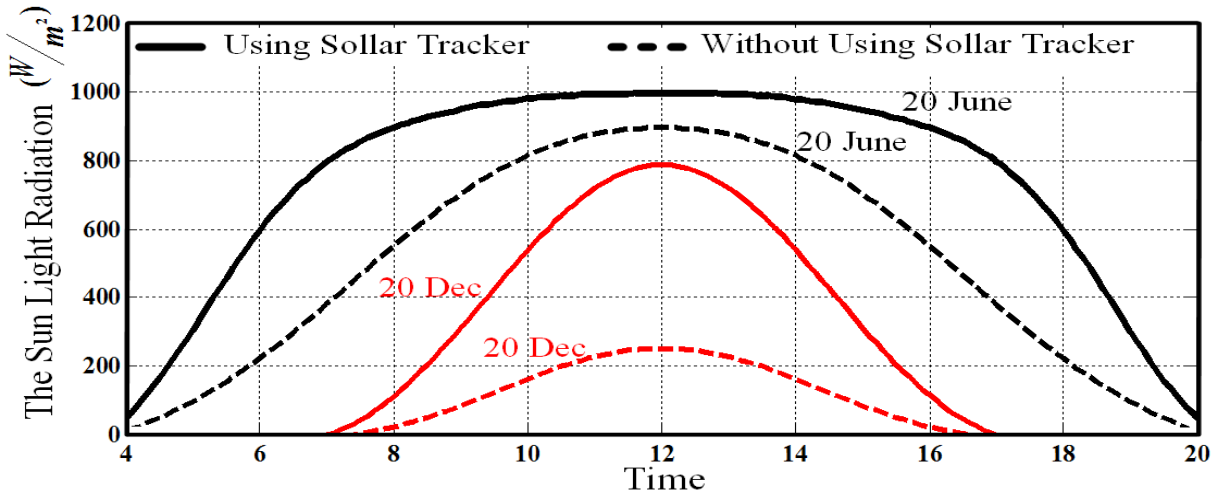

Figure 6. The sunlight radiation on the surface of the solar cell.

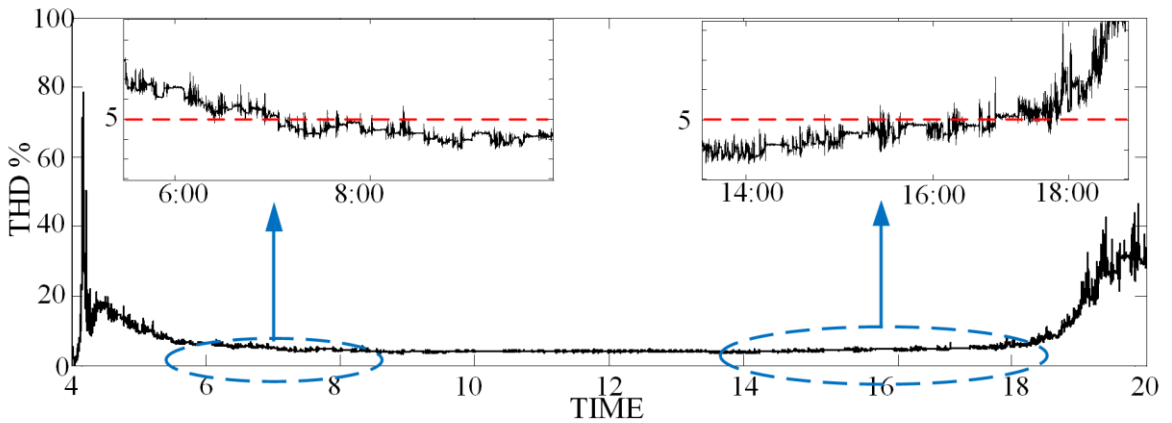

Figure 7. Total harmonic distortion on 20th June using sun tracker technology.

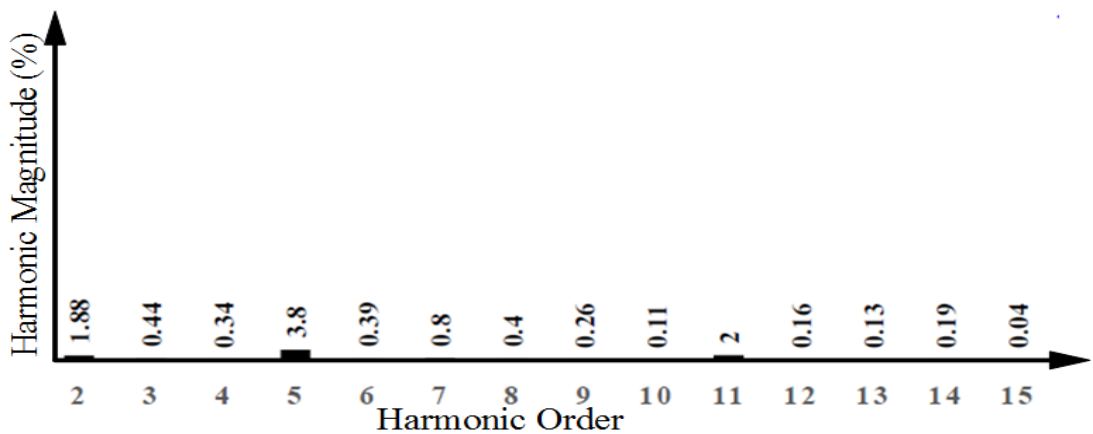

Figure 8. individual harmonic distortion on 20th June using sun tracker technology.

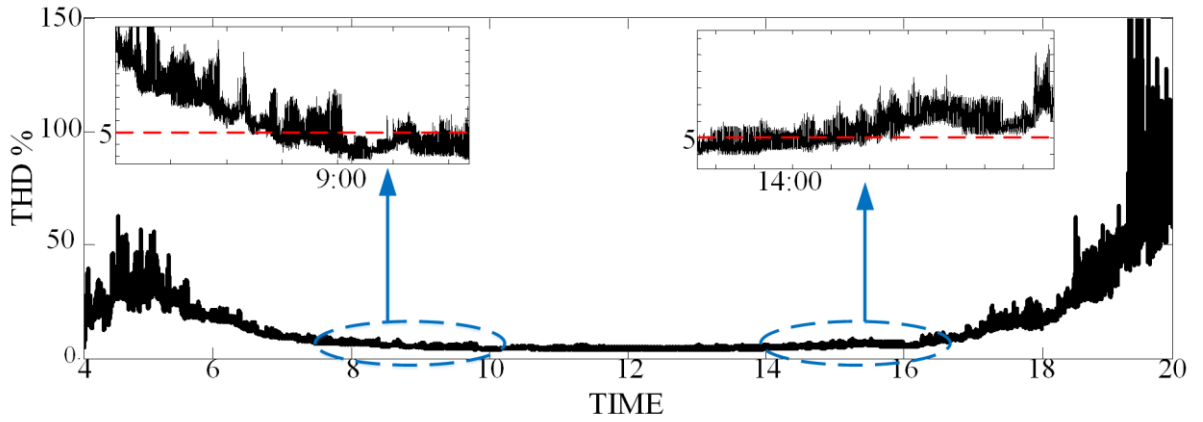

Figure 9. Total harmonic distortion on 20th June without using sun tracker technology.

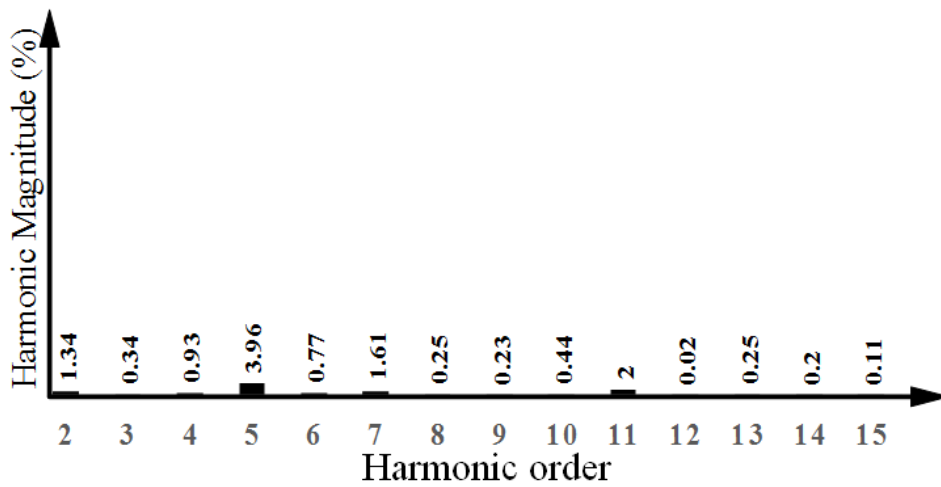

Figure 10. individual harmonic distortion on 20th June without using sun tracker technology.

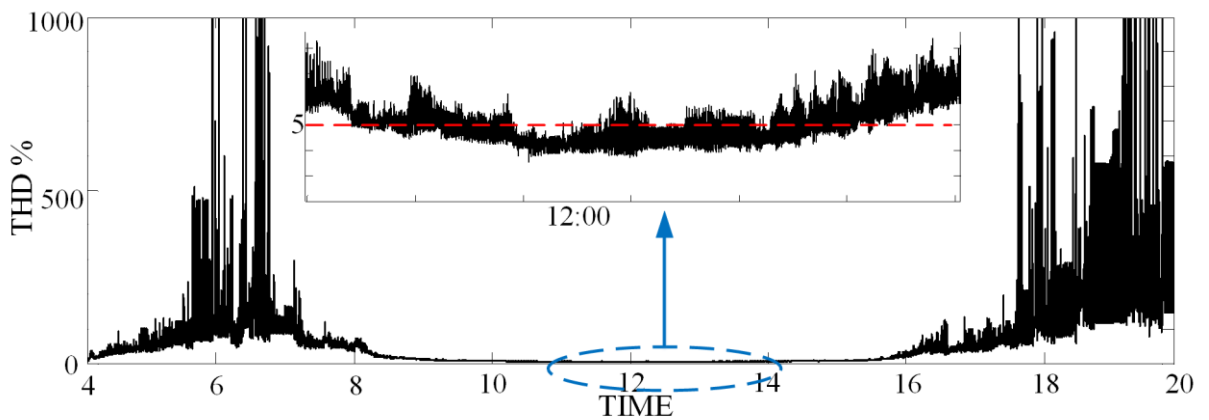

Figure 11. Total harmonic distortion on 20th December using sun tracker technology.

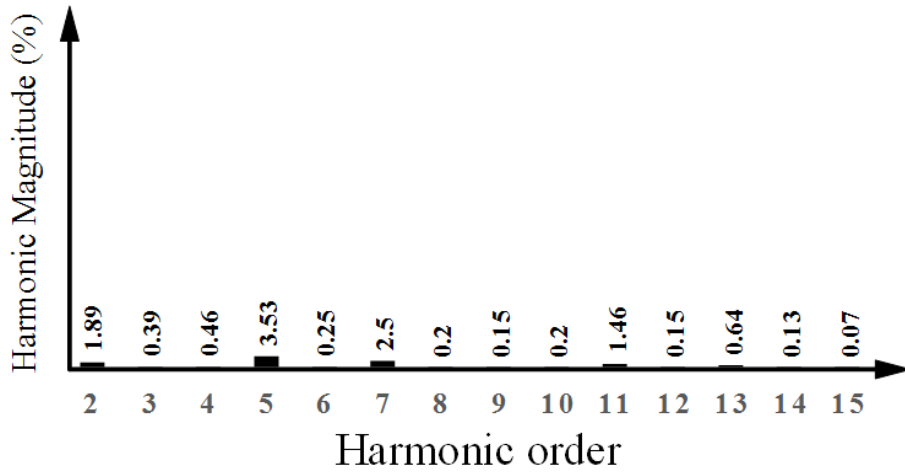

Figure 12. individual harmonic distortion on 20th December using sun tracker technology.

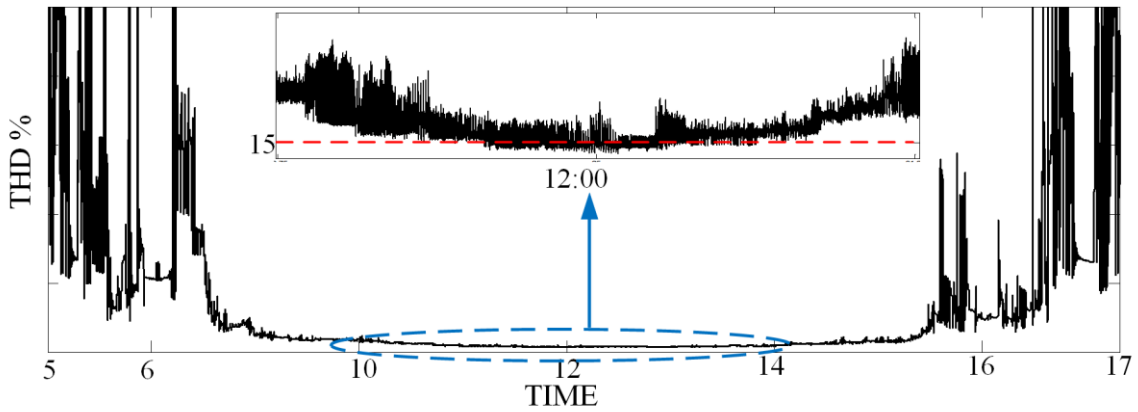

Figure 13. Total harmonic distortion on 20th December without using sun tracker technology.

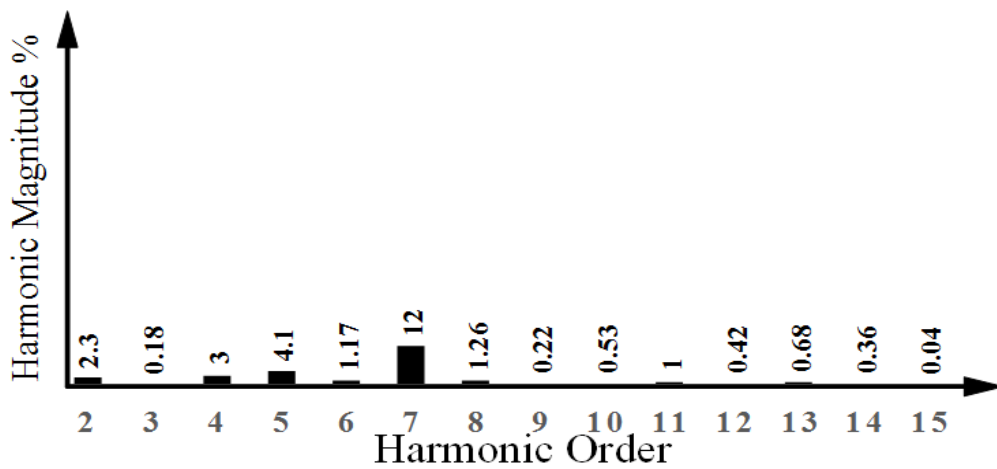

Figure 14. individual harmonic distortion on 20th December without using sun tracker technology.

5. Conclusion

In this paper, the effects of climate change have been investigated on the harmonic distortion of the solar system on the longest and the shortest day of the year and the effect of using a sun tracker technology. Some standards have been discussed for the connection of solar systems to the utility grid. The harmonic distortion analyses have been carried out for output current at the point of common coupling and compared with the specified limits in the standard IEEE STD 519-1992. The solar system must be disconnected from the utility grid system in the hours that the harmonics produced by the solar system exceed the standard limits. Moreover, to increase hours of solar energy access, the sun tracker can be used in compliance with statutory standards.

References

- [1] Chidurala, A., Saha, T. K., & Mithulananthan, N. (2016). Harmonic impact of high penetration photovoltaic system on unbalanced distribution networks—learning from an urban photovoltaic network. *IET Renewable Power Generation*, 10(4), 485-494.
- [2] Bhuyan, S., Singh, K., Kumar, M. N., & Mishra, S. (2017, December). A Study on Performance Analysis of 75kWp Grid Connected Solar Power Plant at MEMS. In 2017 International Conference on Computer, Electrical & Communication Engineering (ICCECE) (pp. 1-5). IEEE.
- [3] Tamimi, B., Cañizares, C., & Bhattacharya, K. (2013). System stability impact of large-scale and distributed solar photovoltaic generation: The case of Ontario, Canada. *IEEE transactions on sustainable energy*, 4(3), 680-688.
- [4] Sharma, H., Rylander, M., & Dorr, D. (2016). Grid Impacts Due to Increased Penetration of Newer Harmonic Sources. *IEEE Transactions on Industry Applications*, 52(1), 99-104.
- [5] Lamich, M., Balcells, J., Corbalán, M., & Griful, E. (2017). Nonlinear loads model for harmonics flows prediction, using multivariate regression. *IEEE Transactions on Industrial Electronics*, 64(6), 4820-4827.
- [6] Grycan, W., Brusilowicz, B., & Kupaj, M. (2018). Photovoltaic farm impact on parameters of power quality and the current legislation. *Solar Energy*, 165, 189-198.
- [7] Khadkikar, V., Varma, R. K., Seethapathy, R., Chandra, A., & Zeineldin, H. (2012, June). Impact of distributed generation penetration on grid current harmonics considering non-linear loads. In 2012 3rd IEEE International Symposium on Power Electronics for Distributed Generation Systems (PEDG) (pp. 608-614). IEEE.
- [8] Kaveh, M., Farhangi, S., & Iman-Eini, H. (2018, February). A new strategy for load side harmonic reduction using grid-connected photovoltaic inverters. In 2018 9th Annual Power Electronics, Drives Systems and Technologies Conference (PEDSTC) (pp. 341-346). IEEE.
- [9] Jannesar, M. R., Sedighi, A., Savaghebi, M., Anvari-Moghaddam, A., & Guerrero, J. M. (2018, September). Optimal Passive Filter Planning in Distribution Networks with Nonlinear Loads and Photovoltaic Systems. In 2018 20th European Conference on Power Electronics and Applications (EPE'18 ECCE Europe) (pp. P-1). IEEE.
- [10] ESRAM, T., & Chapman, P. L. (2007). Comparison of photovoltaic array maximum power point tracking techniques. *IEEE Transactions on energy conversion*, 22(2), 439-449.
- [11] Rajapakse, A. D., & Muthumuni, D. (2009, October). Simulation tools for photovoltaic system grid integration studies. In 2009 IEEE Electrical Power & Energy Conference (EPEC) (pp. 1-5). IEEE.
- [12] F II, I. (1993). IEEE STD519-1992, IEEE recommended practices and requirements for harmonic control in electrical power systems. New York, NY, USA.
- [13] Salehi, S. M., Dehghan, S. M., & Hasanzadeh, S. (2016, February). Ultra step-up DC-DC converter based on three windings coupled inductor. In 2016 7th Power Electronics and Drive Systems Technologies Conference (PEDSTC) (pp. 171-176). IEEE.
- [14] Salehi, S. M., Dehghan, S. M., & Hasanzadeh, S. (2018). Interleaved-Input Series-Output Ultra-High Voltage Gain DC-DC Converter. *IEEE Transactions on Power Electronics*, 34(4), 3397-3406.
- [15] Carrasco, J. A., de Quiros, F. J. G., Alaves, H., & Navalon, M. (2018). An Analog Maximum Power Point Tracker with Pulse Width Modulator Multiplication for a Solar Array Regulator. *IEEE Transactions on Power Electronics*.

[16] IEEE. (2000). IEEE recommended practice for utility interface of photovoltaic (PV) systems. IEEE.

[17] Hester, S. (2002). IEEE 929–2000 Recommended Practice for Utility Interface of Photovoltaic (PV) Systems. In Workshop Proceedings-Solar Electric Power Association.